



technical data sheet

Product code :	2011465 – 2011466 – 2011467
Description :	<u>PLINTHS FOR DATACENTER TECH CABINETS</u>

Plinths for Datacenter TECH cabinets.

CODE		DESCRIPTION	DIMENSIONS (mm)		
Gray	Black		W	D	H
2011465	2011465N	Plinths for Datacenter TECH cabinet W600xD1000	600	956	100
2011466	2011466N	Plinths for Datacenter TECH cabinet W800xD1000	800	956	100
2011467	2011467N	Plinths for Datacenter TECH cabinet W800xD1200	800	1156	100

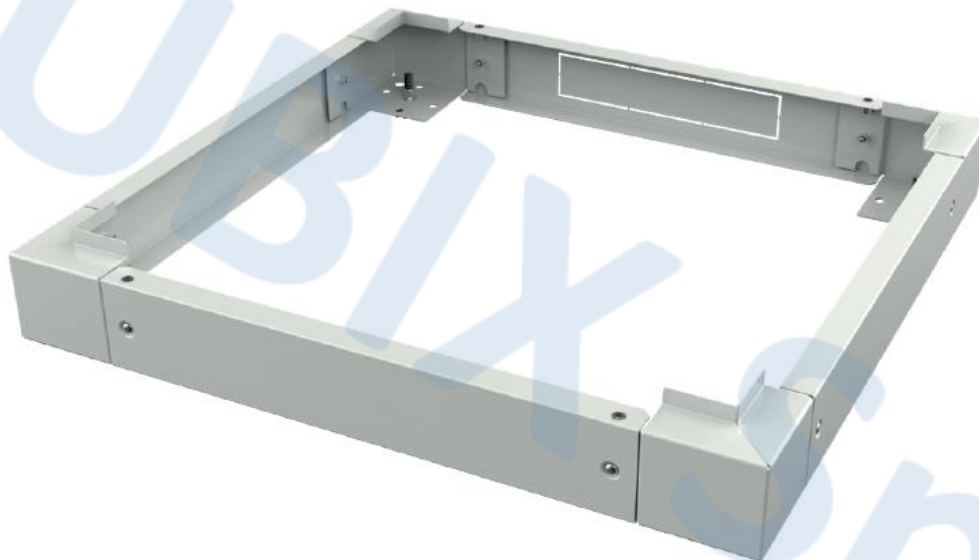

MAIN FEATURES

- 4 removable flanges for the passage of cables
- 4 angle brackets
- Removable micro joint in the rear arranged for the installation of a cable brush
- Structure in painted steel sheet, 2 mm
- Color gray RAL 7035 or black RAL 9005
- Height 100 mm
- Mounting screws
- Predisposition for the installation of levelling feet or castors
- Load capacity: 1500 Kg (900 Kg with castors)



technical data sheet

Product code :	2011465 – 2011466 – 2011467
Description :	<u>PLINTHS FOR DATACENTER TECH CABINETS</u>

TECHNICAL DRAWINGS

PLINTHS W=600

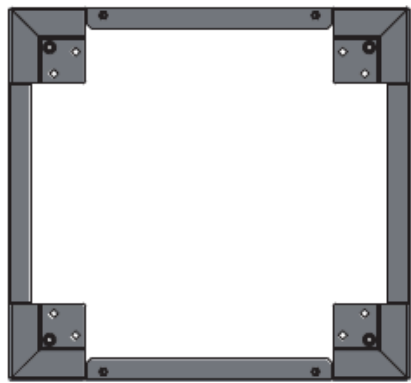
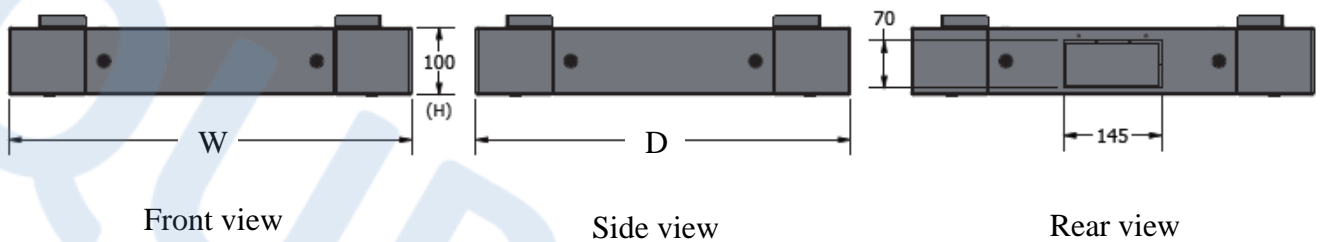

Top view

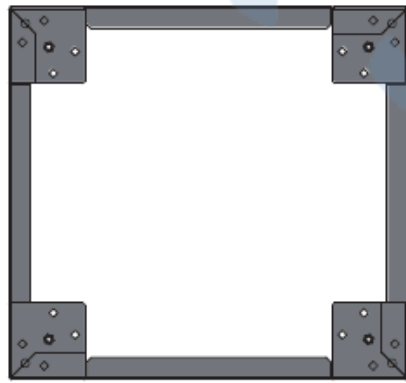

Bottom view



Product code :	2011465 – 2011466 – 2011467
Description :	<u>PLINTHS FOR DATACENTER TECH CABINETS</u>

TECHNICAL DRAWINGS

PLINTHS W=800

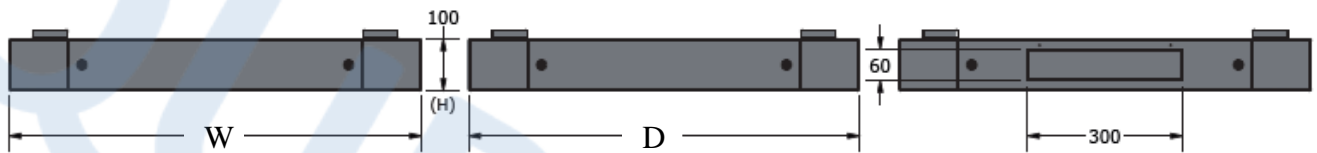

Front view

Side view

Rear view

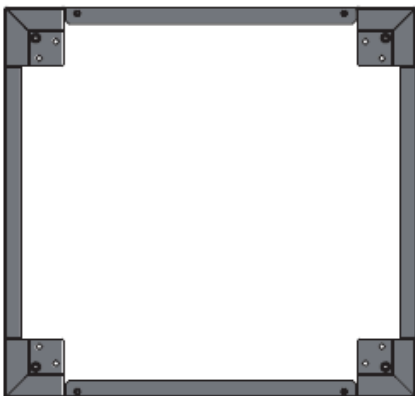

Top view

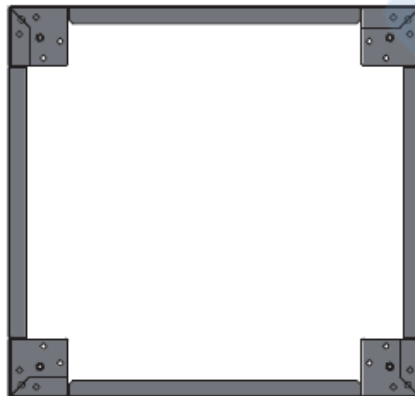

Bottom view